

Introduction & Features

FEA2SCN is a SCN-module to virtually scan Finite Element Analyses assumed to be placed in a flat baffle:

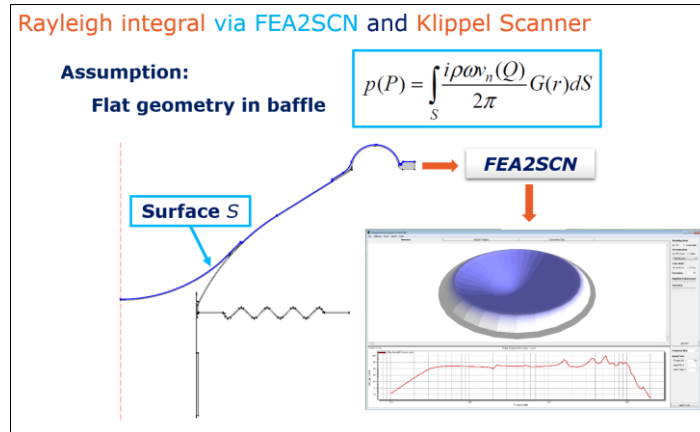

FEA2SCN interpolates vibrational data from non-structured FEA-meshes to data on structured Klippel Scanner grids to enable FEA-analysts to:

- do acoustic and acceleration **decomposition** of FEA-results (see AN31) and
- significantly **reduce long computational run-times** of vibroacoustic 3D simulations of non-axisymmetric transducers, passive radiators (slave units), loudspeaker cabinets and other approximately plane surfaces such as car doors.

FEA2SCN performs virtual scanning of 2D axisymmetric models, full 3D-models and 3D-models where symmetry has been exploited such as cyclic, half-mirror or quarter-mirror symmetry. 3D-models can be arbitrarily orientated, but must be scanned in a direction that is perpendicular to one of the coordinate planes.

FEA2SCN accepts all shapes to be scanned virtually, for example surfaces with holes in them or if transducers/passive radiators are rectangular, oval or other shapes.

For virtual scanning of electromagnetic transducers, the FEA-model can:

- either contain the electromagnetic motor system
- or the LR-2 T/S-parameters can be superimposed during the interpolation process for FEA-models only consisting of the structural moving parts.

The FEA2SCN module accepts multiple input files enabling the user to parallelise the solving of a number of frequency ranges of the same FEA-model distributed on a number of individual computers. The FEA2SCN module automatically expand symmetric models for improved visual inspection and the ability to enable the scanners "Radiation Analysis".

Two companion modules exist for FEA2SCN. One is for ANSYS called "FEA2SCN-ANSYS". The other is for COMSOL Multiphysics called "FEA2SCN-COMSOL". Modules for other FEA-tools can be developed – contact iCapture ApS (see below). This application note provides a step-by-step procedure for estimating sound pressure for transducers and cabinets via displacement data from a Finite Element Analysis. COMSOL users should omit pages 9-11, whereas ANSYS user should omit pages 5-8.



Klippel GmbH
Mendelssohnallee 30
01309 Dresden, Germany
www.klippel.de
info@klippel.de



True Technologies Inc.
8309 West Ridge Drive
Pleasant Prairie, WI 53158
USA
www.true-technologies.com
rtrue@true-technologies.com

Contents

Contents	2
Requirements	3
Limitations	3
Supported FEA platforms	4
FEA-Model Setup	7
Exporting Surface Displacements in COMSOL	7
Exporting Surface Displacements in ANSYS.....	12
Setting Up The Import Options.....	14
Running the CAL-module in “dB-Lab”	18
Running the “SCN Analysis Software”	20
FEA2SCN Files	21
Introduction “Ready-To-Scan”-Models	22
More Information.....	28
FEA2SCN Version.....	28
Document Revision.....	28



Klippel GmbH
Mendelssohnallee 30
01309 Dresden, Germany
www.klippel.de
info@klippel.de



True Technologies Inc.
8309 West Ridge Drive
Pleasant Prairie, WI 53158
USA
www.true-technologies.com
rtrue@true-technologies.com

Requirements	
dB-Lab	Use of the FEA2SCN interpolation for SCN requires an installation of the Klippel “dB-Lab” software, which can be downloaded from http://www.klippel.de/dm/
CAL	Use of the FEA2SCN interpolation for SCN requires an installation of the Klippel “SciEngine” software, which can be downloaded from http://www.klippel.de/dm/
Interface FEA/BEA	Use of the FEA2SCN interpolation for SCN requires an “Interface FEA/BEA” license. Please contact support@klippel.de to purchase the module.
SCN Analysis Software	Use of the FEA2SCN interpolation for SCN requires a license of the “SCN Analysis Software”. Please contact support@klippel.de to purchase the software.

Limitations	
Mounting	The acoustic radiation processing presumes that the scanned surface is placed in a flat infinite baffle. This is typical for transducer and passive radiator development. For loudspeaker cabinet development or other approximately flat scanned surfaces this means that only one side can be investigated at a time and the user must be aware of the fact that the “SCN Analysis Software” always presumes the scanned surface is mounted in a flat infinite baffle.
Radiation Estimation	The radiation modelling in the ”SCN Analysis Software” is performed by the Rayleigh integral – see AN31. The user must be aware that the Rayleigh integral presumes (in addition to a presumed flat infinite baffle, see Mounting) the scanned surface is flat. If the scanned surface is not flat, which is the case for a typical convex or concave transducer, curved loudspeaker cabinets or car doors, the Rayleigh integral can generate frequency dependent topology inaccuracies in the range of typically +/- 2-5dB in the break up region. The user is advised to identify and compensate for this discrepancy either by vibroacoustic simulations or experimental measurements to avoid poor or even faulty decision-making.



Klippel GmbH
Mendelssohnallee 30
01309 Dresden, Germany
www.klippel.de
info@klippel.de



True Technologies Inc.
8309 West Ridge Drive
Pleasant Prairie, WI 53158
USA
www.true-technologies.com
rtrue@true-technologies.com

Omitted Air Loading	The user must be aware that the FEA data used for FEA2SCN originates from a structural only FEA-model where the air loading is omitted. For a typical cone or dome driver of 3-6 inches this generates a frequency dependent air loading inaccuracy typically in the order of 0.5 dB in the low frequency region.
Model Orientation	2D axisymmetric-models shall be located in the rz-plane (COMSOL) or the xy-plane (ANSYS) oriented with the baffle normal in the z-direction (COMSOL) or y-direction (ANSYS). 3D-models can be placed arbitrarily in space, but the radiating surface to be scanned shall be perpendicular to the +/-x, +/-y or +/-z-axis.
Cyclic Periodic and Mirror Symmetric Models	The FEA2SCN only supports simple cyclic periodic and mirror symmetric boundary conditions having no out-of-plane motion (i.e. FEA2SCN does not support “azimuthal wave-number” or “harmonic index” which is an integer that determines the variation in the value of a single degree of freedom at points spaced at a circumferential angle equal to the sector angle).
Model Size	<p>Due to the Klippel SciEngine software being limited in maximum allocated memory, care shall be take on restricting the mesh size and number of frequencies in the FE analysis. The output files size (*.sce) must generally not exceed 1 GB, which by experience is known to be more than sufficient to obtain high fidelity results.</p> <p>The Klippel SCN software currently allows a maximum number of 50000 grid points. The memory requirements of the Klippel scanner are mainly determined by the restrictions of Scilab. That means any data amount, which can be processed by the Cal script will most likely also be processable by the SCN software. But for performance reasons we recommend to limit the model size to about 5000-10000 grid points and less than 500 frequencies. A logarithmic frequency axis is preferable for analysis due to the constant relative bandwidth over the whole frequency range.</p>

Supported FEA platforms

COMSOL	v4.3b, v4.4
ANSYS	v12.0, v14.0, v14.5, v14.5.7



Klippel GmbH
Mendelssohnallee 30
01309 Dresden, Germany
www.klippel.de
info@klippel.de



True Technologies Inc.
8309 West Ridge Drive
Pleasant Prairie, WI 53158
USA
www.true-technologies.com
rtrue@true-technologies.com

FEA-Model Setup

CAD-model The premise to use and benefit from FEA2SCN is that an accurate FEA-model exists. Note, models in the FEA software must be processed with space units set to meters "m". If the geometry is created in another CAD package (e.g., Solidworks) with other dimensions such as millimeters, then follow these steps (for COMSOL)

Set the Geometry Settings node so the units are those of the CAD file

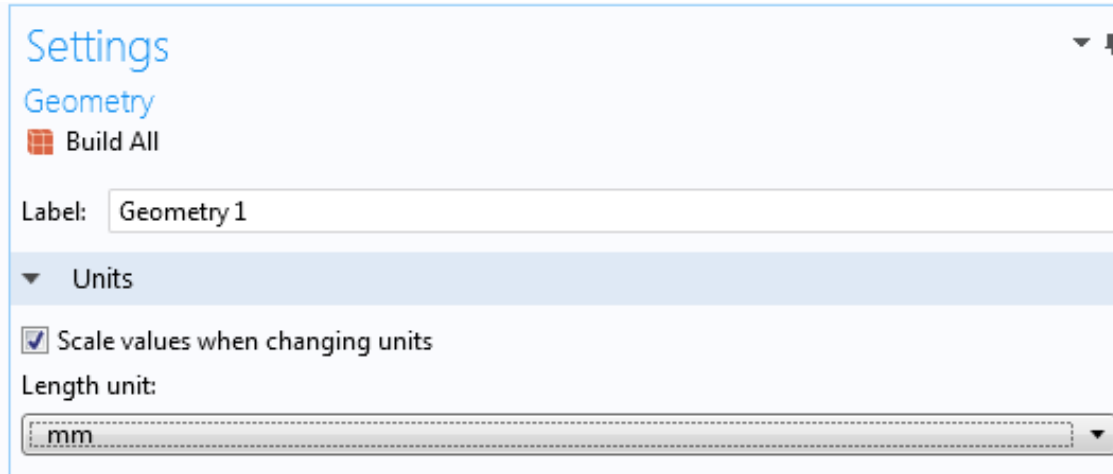

Next, if using Solidworks LiveLink, set it up as below

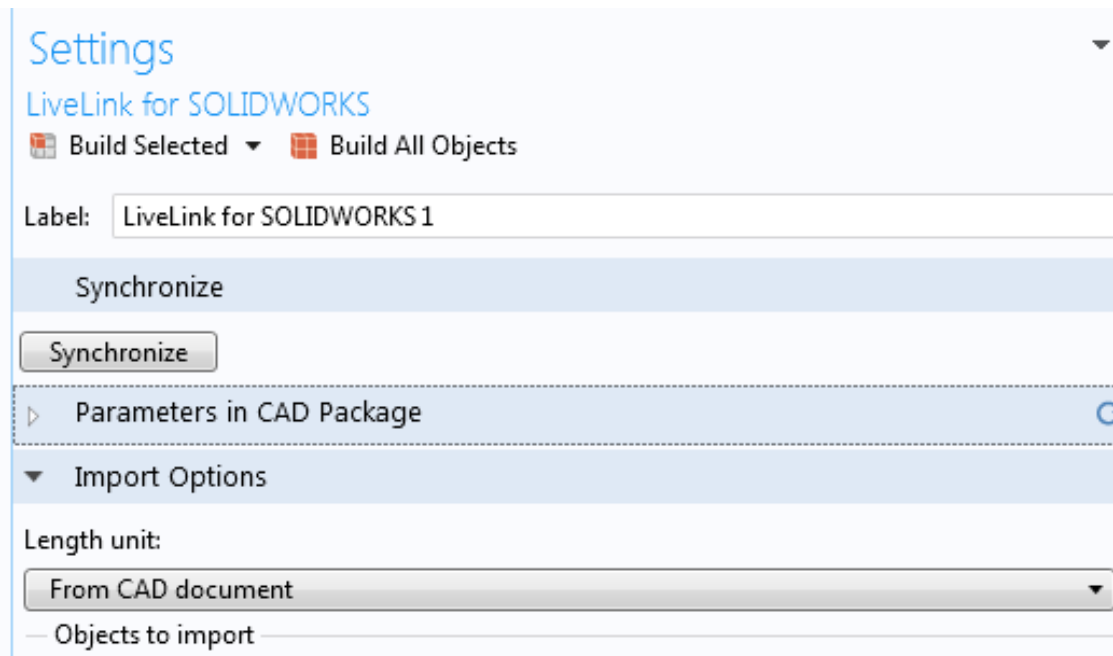

Klippel GmbH
Mendelssohnallee 30
01309 Dresden, Germany
www.klippel.de
info@klippel.de



True Technologies Inc.
8309 West Ridge Drive
Pleasant Prairie, WI 53158
USA
www.true-technologies.com
rtrue@true-technologies.com

Finally, go back the Geometry Settings node and check the "Scale values when changing units" box and the change the Length unit drop down to "m". You should note the geometry change size in the graphics window (in this case it will appear very small as it scaled by 1/1000th of the CAD)

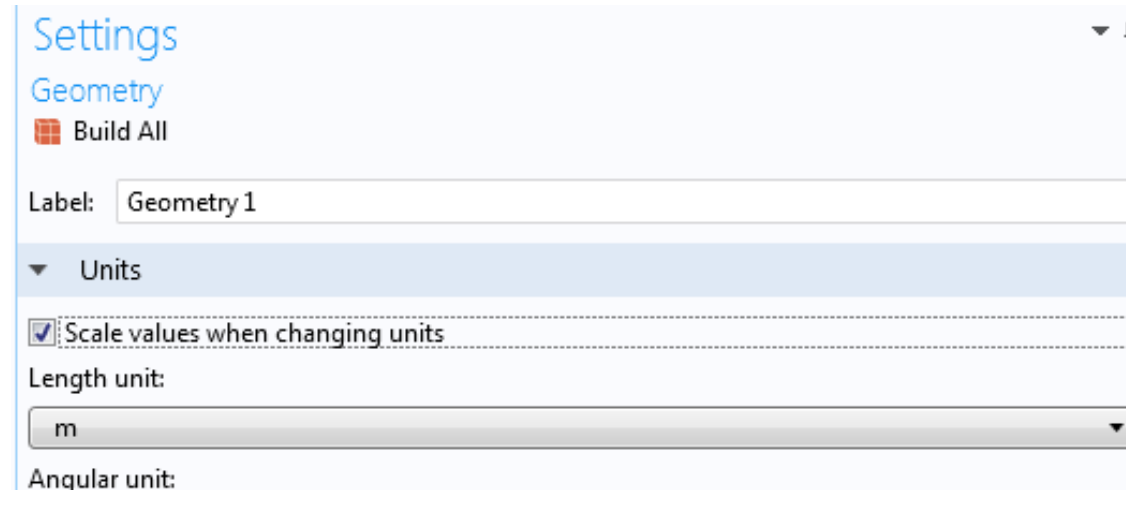

Klippel GmbH
Mendelssohnallee 30
01309 Dresden, Germany
www.klippel.de
info@klippel.de



True Technologies Inc.
8309 West Ridge Drive
Pleasant Prairie, WI 53158
USA
www.true-technologies.com
rtrue@true-technologies.com

FEA-Model Setup (continued)

CAD-model The premis to use and benefit from FEA2SCN is that an accurate FEA-model exist.

Material

Properties

The FEA-model shall be setup and solved as usual accordingly to the companys best-practice concerning:

Boundary Conditions

- preparing the CAD-model with a baffle and, if needed, air in a rear chamber

Meshing

- applying typical material properties and
- setting up all usual boundary conditions.

The mesh of all the model's scanned edges or surfaces shall have an approximately uniform mesh size to avoid interpolation errors.

Exporting Surface Displacements in COMSOL

Selecting the boundary (2D) or surface (3D)

It is assumed that a Finite Element Analysis has been carried out with:

- 1) either a total force of 1 N^1 on the voice coil where the motor will be included via entered small-signal parameters,
- 2) or a full electromagnetic-vibroacoustic analysis with an input voltage of 1 V^2 on the voice coil. The electromagnetic behaviour can be included via COMSOL's AC/DC-module either in the continuous-parameter FEA-domain or as a lumped-parameter circuit model.

Displacements on the radiating boundary (2D) or surface (3D) are to be exported in a format, which can be read by the FEA2SCN software.

For 2D analyses the displacements are taken on the radiating

¹ Note that the force of 1 N corresponds to a full model without considering any possible symmetry in the model. If however symmetry (along planes or cyclic) is taken advantage of, the applied force in the FE analysis must be divided by the symmetry number. So for a model with a single symmetry plane the applied force should be $\frac{1}{2} \text{ N}$ in FEA or for a quarter symmetric model the force shall be $\frac{1}{4} \text{ N}$.

² Note that the voltage of 1 V corresponds to a full model without considering any possible symmetry in the model. If however symmetry (along planes or cyclic) is taken advantage of, the applied voltage in the FE analysis must be divided by the symmetry number. So for a model with a single symmetry plane the applied force should be $\frac{1}{2} \text{ V}$ in FEA or for a quarter symmetric model the voltage shall be $\frac{1}{4} \text{ V}$.



Klippel GmbH
Mendelssohnallee 30
01309 Dresden, Germany
www.klippel.de
info@klippel.de



True Technologies Inc.
8309 West Ridge Drive
Pleasant Prairie, WI 53158
USA
www.true-technologies.com
rtrue@true-technologies.com

boundary. Right-click *Results-Data Sets* and select *Boundary*. Select all boundaries that make up the entire radiating surface:

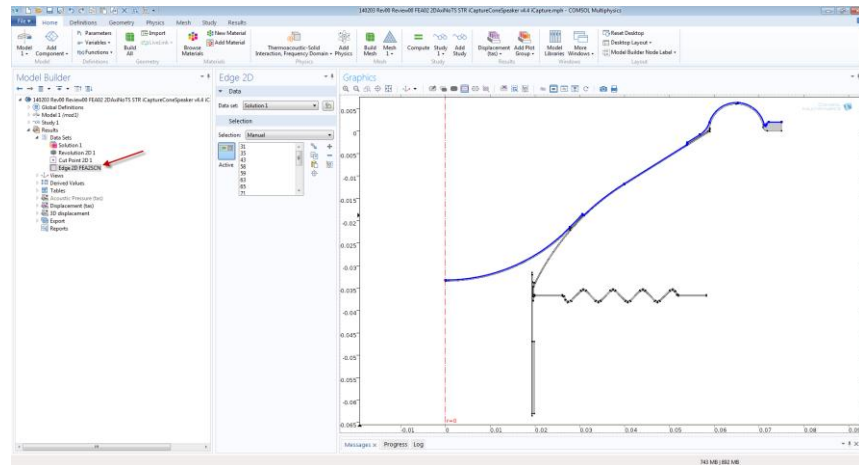

For 3D analyses the displacements are taken on a radiating surface. Right-click *Results-Data Sets* and select *Surface*. Select all surfaces that make up the entire radiating surface:

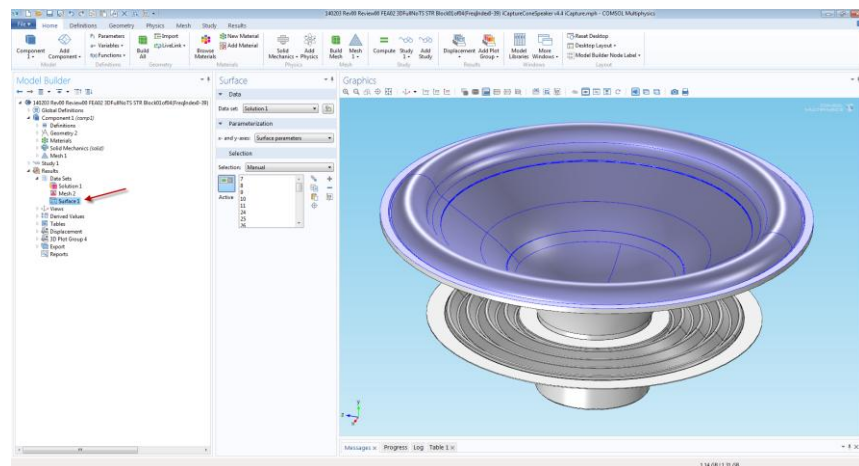

Exporting displacements

Right-click on *Results-Export* and select *Data*. Under *Data set* select the surface created earlier. Two variables must be exported, namely the amplitude and the phase of the displacement in the direction of the outwards normal of the imaginary baffle. Select a filename which ends with “*Block01of01.txt*”. The data format has to be *Sectionwise*. If the FEA-model uses 2nd order elements then under *Advanced* select *Resolution: Custom* and *Lagrange-element node-point order: type 2*.

For some cases having a high computational burden generating large data files it may be advantageous to work with multiple



Klippel GmbH
Mendelssohnallee 30
01309 Dresden, Germany
www.klippel.de
info@klippel.de



True Technologies Inc.
8309 West Ridge Drive
Pleasant Prairie, WI 53158
USA
www.true-technologies.com
rtrue@true-technologies.com

blocks of data, e.g. if the analysis has been split into a number of frequency ranges to be run on a number of different computers in parallel. In such cases two or more export files are created, each covering a part of the entire frequency range of interest. The filenames shall only differ in their block number. For example, if two export files are desired, the lower frequency range simulation file is named “*Filename Block01of02.txt*”, and the second export file covering the upper frequency range is named “*Filename Block02of02.txt*”.

The figure below shows an example of the data node setup for a case where the direction of interest is along the y-axis, with two data nodes to create two separate export files. The COMSOL “*acsl*” identifier in the export expression (“*solid.uAmpY*” and “*solid.uPhY*”) indicates that the *Solid Mechanics, Frequency Domain* module has been utilized. This identifier will depend on the study in question.

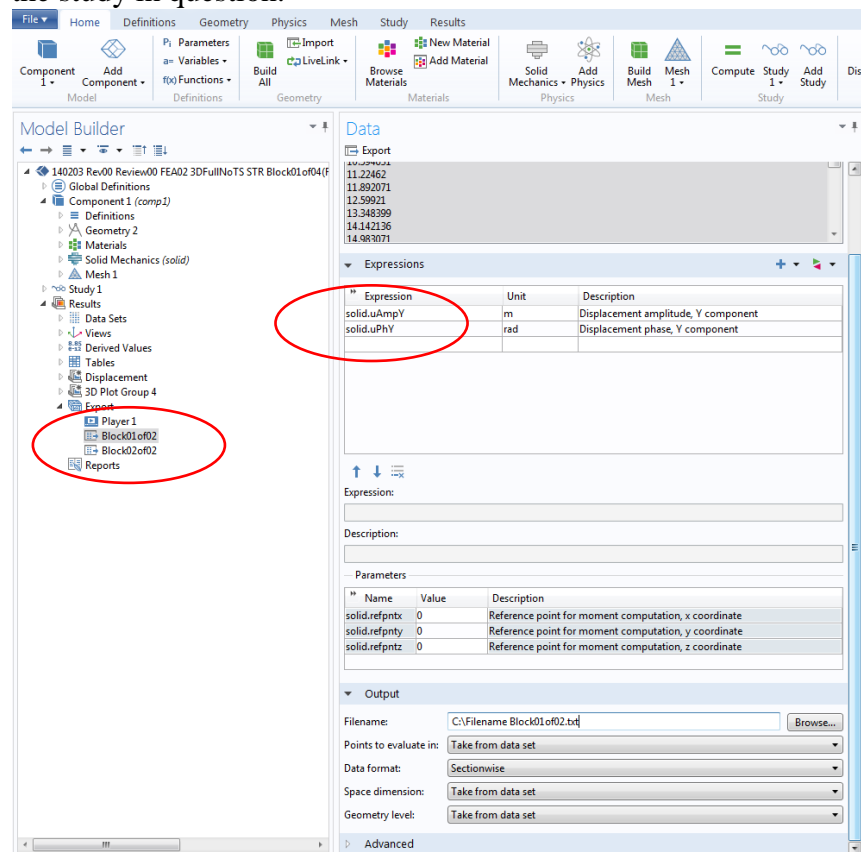

The advanced section should look like below:



Klippel GmbH
Mendelssohnallee 30
01309 Dresden, Germany
www.klippel.de
info@klippel.de



True Technologies Inc.
8309 West Ridge Drive
Pleasant Prairie, WI 53158
USA
www.true-technologies.com
rtrue@true-technologies.com

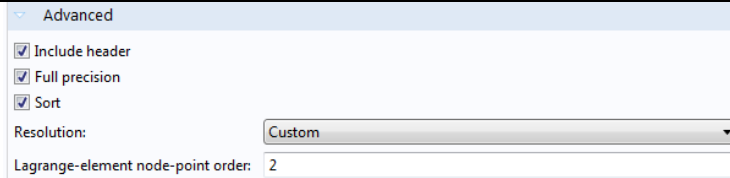

Exporting velocities (for superimposing the motor T/S-parameters in FEA2SCN)

If the simulation is a transducer not including the electromagnetic motor the simulation is set up with a constant force on the voice coil. The electromagnetic behaviour of the motor must instead be included in FEA2SCN. This entails creating a small file, which holds the average velocity of the voice coil windings for each frequency.

First an average operator (see COMSOL Manual) is set up in COMSOL. Right-click on *Definitions* and select *Model Couplings-Average*.

The operator name is renamed to e.g. “*AveOpOnWindings*”, to indicate that it is an **Average Operator On the Windings**.

Select the domain, which corresponds to the voice coil windings. Next, right-click on *Definitions* and select *Variables* (if the *Variables node* is not already present).

Create a variable named “*AveWindingsVelo*”.

This variable will hold the average velocity of the windings in the y-direction using the average operator just defined. The expression for the variable is “*AveOpOnWindings(i*2*pi*freq*v)*” assuming:

- 1) that the direction of the baffle outwards normal is Y along the y-axis and
- 2) that the displacement component in the y-direction is called “v”.

Please check for the current module what the dependent variables are called.

Now, right-click on *Results-Derived Values* and select *Global Evaluation*. In expression type “*real(AveWindingsVelo)*”.

Press *Evaluate*. Create a second global evaluation node with the expression “*imag(AveWindingsVelo)*” and evaluate **in the same table as the real part**.

Click on the Export button marked with a red arrow in the figure



below:

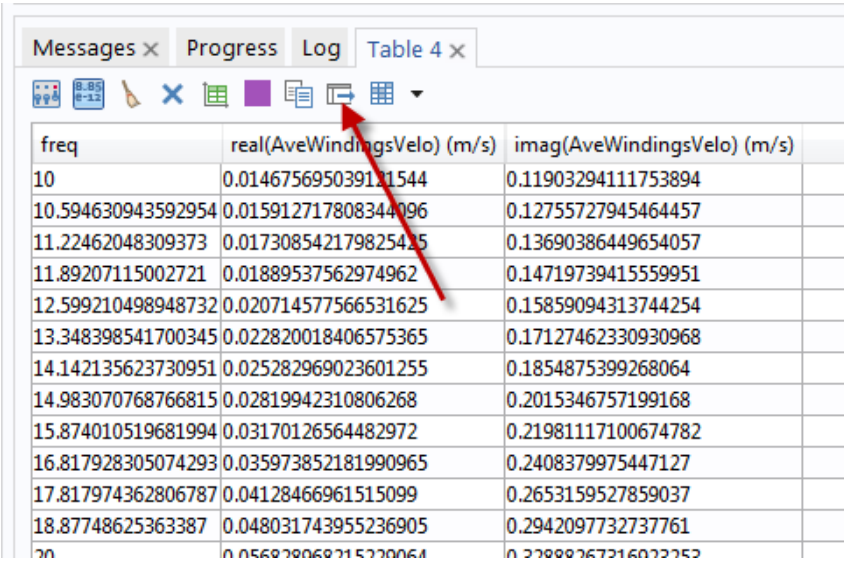

freq	real(AveWindingsVelo) (m/s)	imag(AveWindingsVelo) (m/s)
10	0.014675695039111544	0.11903294111753894
10.594630943592954	0.015912717808344096	0.12755727945464457
11.22462048309373	0.017308542179825425	0.13690386449654057
11.89207115002721	0.01889537562974962	0.14719739415559951
12.599210498948732	0.020714577566531625	0.15859094313744254
13.348398541700345	0.022820018406575365	0.17127462330930968
14.142135623730951	0.025282969023601255	0.1854875399268064
14.983070768766815	0.02819942310806268	0.2015346757199168
15.874010519681994	0.03170126564482972	0.21981117100674782
16.817928305074293	0.035973852181990965	0.2408379975447127
17.817974362806787	0.04128466961515099	0.2653159527859037
18.87748625363387	0.048031743955236905	0.2942097732737761

Name the file “*Filename Block01of0x velo.txt*”, where “*x*” is 1 if only a single block (frequency range) is considered.

Note that to distinguish this exported velocity file from the exported displacement file the file name contains the string “*velo*”. There must be as many velocity output files as there are displacement output files, with corresponding frequency ranges.



Klippel GmbH
Mendelssohnallee 30
01309 Dresden, Germany
www.klippel.de
info@klippel.de



True Technologies Inc.
8309 West Ridge Drive
Pleasant Prairie, WI 53158
USA
www.true-technologies.com
rtrue@true-technologies.com

Exporting Surface Displacements in ANSYS

Selecting the edge (2D) or surface (3D)

It is assumed that a Finite Element Analysis is to be carried out with:

- 1) either a total force of 1 N^3 on the voice coil where the motor will be included via entered small-signal parameters,
- 2) or a full electromagnetic-vibroacoustic analysis with an input voltage of 1 V^4 on the voice coil. The electromagnetic behaviour can be included in the continuous-parameter FEA-domain in ANSYS.

Displacements on the radiating edges (2D) or surfaces (3D) are to be exported in a format, which can be read by the FEA2SCN software.

For 2D analyses the displacements are taken on a radiating edge. Create a named selection for the edge/boundaries to be scanned and name it:

“FEA2SCN_ExportEdgeOrFace”:

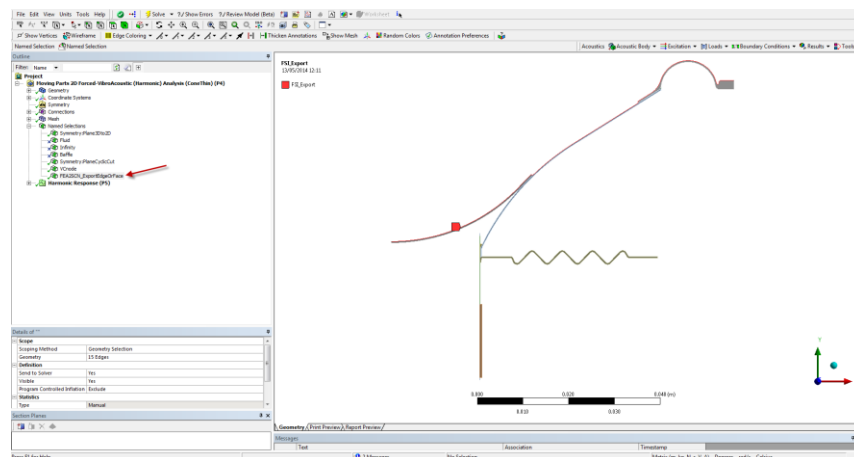

³ Note that the force of 1 N corresponds to a full model without considering any possible symmetry in the model. If however symmetry (along planes or cyclic) is taken advantage of, the applied force in the FE analysis must be divided by the symmetry number. So for a model with a single symmetry plane the applied force should be $\frac{1}{2} \text{ N}$ in FEA or for a quarter symmetric model the force shall be $\frac{1}{4} \text{ N}$.

⁴ Note that the voltage of 1 V corresponds to a full model without considering any possible symmetry in the model. If however symmetry (along planes or cyclic) is taken advantage of, the applied voltage in the FE analysis must be divided by the symmetry number. So for a model with a single symmetry plane the applied force should be $\frac{1}{2} \text{ V}$ in FEA or for a quarter symmetric model the voltage shall be $\frac{1}{4} \text{ V}$.

In 3D make a named selection which contains all vibrating surfaces that are to be scanned. Create a named selection for the edge/boundaries to be scanned and name it:

“FEA2SCN_ExportEdgeOrFace”:

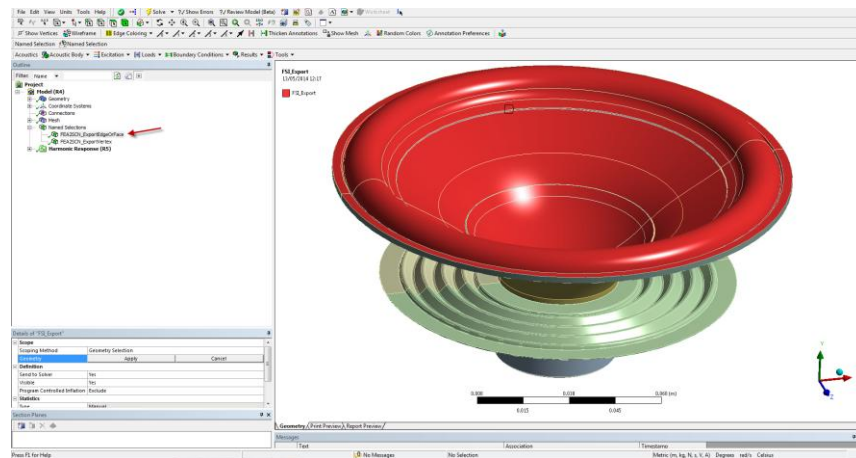

Exporting displacements

In order to export the displacements on the selected edges/boundaries a Commands object must be inserted. Right-click on *Harmonic Response* and select *Insert Commands*. Go to the now inserted "Command Object node", right-click and select *Import...* Click yes to the dialog box and point to the command file (included in the installation) corresponding to the direction of the baffle normal, e.g.

“FEA2SCN v1.0 DisplacementOnEdgeOrFaceXdirection.txt” for the x-direction, and click Open. The command object may be renamed. Once the analysis has been run, an export file called “MyFileName Block01of01.txt” containing the displacements is saved to the folder “.../ProjectName_files/dp0/SYS-X/MECH/” where *ProjectName* is the name of the *.wbpj file. Copy the file to the folder, which is to hold the resulting scan file from the FEA2SCN interpolation procedure. Rename it to *Filename Block0xof0y.txt*, where *x* and *y* are the relevant numbers, typical 1 and 1.

The above procedure is valid for 2D and 3D analyses. For 2D analysis the baffle normal must point in the y-direction.

Exporting velocities (for superimposing the motor T/S-parameters in FEA2SCN)

If the simulation is a transducer not including the electromagnetic motor the simulation is set up with a constant force on the voice coil. The electromagnetic behaviour of the motor must instead be included in FEA2SCN. This entails creating a small file, which holds the velocity on the voice coil windings for each frequency. Create a named selection on a vertex on the windings and name it “FEA2SCN_ExportVertex”. The velocity on this vertex shall be representative of the average velocity over the entire windings



Klippel GmbH
Mendelssohnallee 30
01309 Dresden, Germany
www.klippel.de
info@klippel.de



True Technologies Inc.
8309 West Ridge Drive
Pleasant Prairie, WI 53158
USA
www.true-technologies.com
rtrue@true-technologies.com

domain.

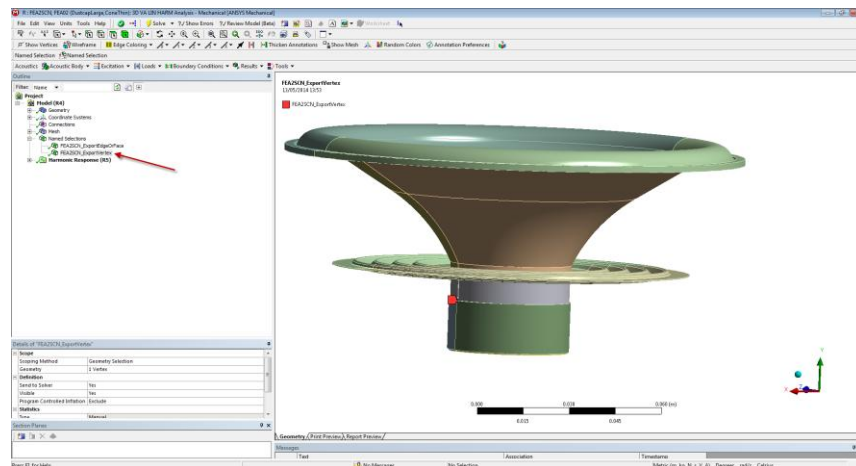

The velocity on the vertex is to be written in an output file via a command object. Right-click on *Harmonic Response* and select *Insert Commands*. Go to the now inserted command object node, right-click and select *Import...* Say yes to the dialog box and point to the file which corresponds to the direction of the baffle normal, e.g. “*FEA2SCN v1.0 VelocityOnVertexXdirection.txt*“ for x-direction, and click Open. The command object may be renamed.

Once the analysis has been run, an export file called “*MyFileName Block01of01 velo.txt*“ containing the velocities is saved to the folder “*.../ProjectName_files/dp0/SYS-X/MECH*” where *ProjectName* is the name of the *.wbproj file and *X* is the analysis number. Copy the file to the folder, which is to hold the resulting scan file from the FEA2SCN interpolation procedure. Rename it to “*Filename Block0xof0y velo.txt*”, where *x* and *y* are the relevant numbers, typical 1 and 1.

Note that to distinguish this exported velocity file from the exported displacement file the velocity file name contains the string “*velo*”.

There must be as many velocity output files as there are displacement output files, with corresponding frequency ranges.

The above procedure is valid for 2D and 3D analyses. For 2D analysis the baffle normal must point in the y-direction.

Setting Up The Import Options

FEA2SCN setup It is important to set up the import options so that they corresponds to the input file created from the Finite Element



Klippel GmbH
Mendelssohnallee 30
01309 Dresden, Germany
www.klippel.de
info@klippel.de



True Technologies Inc.
8309 West Ridge Drive
Pleasant Prairie, WI 53158
USA
www.true-technologies.com
rtrue@true-technologies.com

Analysis.

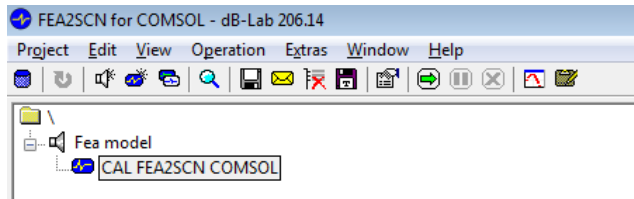

Right-click on "CAL FEA2SCN COMSOL" if the FE analysis was carried out in COMSOL, or "CAL FEA2SCN ANSYS" if ANSYS was used and the *Options window* will appear.

Options

The options windows top half:

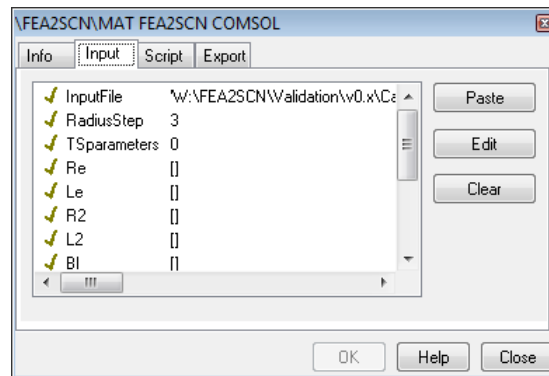

and the bottom half:

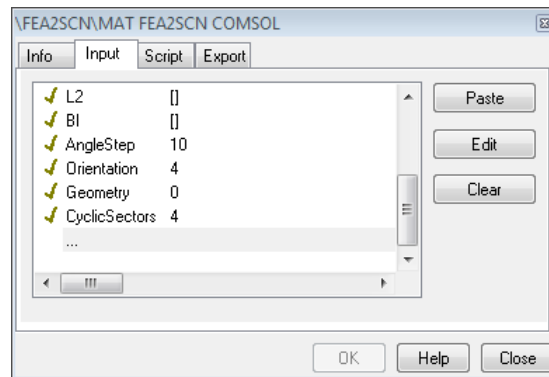

Below is a description of all options.

Note that there is no parameter to indicate whether the dimension of the FEA simulation is 2D or 3D. Instead this is automatically determined by FEA2SCN. This implementation has the effect that some of the parameters must be input for 2D cases, despite they are not used in the interpolation process. This is the case for the



Klippel GmbH
Mendelssohnallee 30
01309 Dresden, Germany
www.klippel.de
info@klippel.de



True Technologies Inc.
8309 West Ridge Drive
Pleasant Prairie, WI 53158
USA
www.true-technologies.com
rtrue@true-technologies.com

parameters *Orientation* and *Geometry* for 2D acoustic cases. In the following parameter description it is indicated in square brackets for which cases an input is required.

InputFile [All cases]

Enter the file name for the file containing the displacement file including folder name. The last part of the filename must be “*Block01ofxy.txt*”, where *xy* indicates the last block number, typically 01. If velocity output files are also present they shall be named “*Block01ofxy velo.txt*”.

RadiusStep [All cases]

The distance step in millimetres between interpolation points along the radial direction. The user is advised to use the same distance step as the mesh size. It can not be recommended to use a distance step smaller than half of the mesh size. The user must take proper care to spatially resolve the given structure both concerning the mesh size setup in the FEA tool (avoiding a too coarse and too stiff mesh) as well as the distance step setup in FEA2SCN. FEA mesh size and FEA2SCN distance step is dependent on the application.

TSparameters [All cases]

This must be set in accordance with the FEA and can either be:

0. *Exclude* (T/S-parameters are already included in the FEA).
1. *Include* (FEA2SCN is to include the effect of the motor).

Re [All cases, if parameter *TSparameter* is “1”]

The DC resistance of the coil windings in Ohms.

Le [All cases, if parameter *TSparameter* is “1”]

The inductance of the coil winding in Henry.

R2 [All cases, if parameter *TSparameter* is “1”]

The para-resistance of the LR-2 model in Ohms.

L2 [All cases, if parameter *TSparameter* is “1”]

The para-inductance of the LR-2 model in Henry.

Bl [All cases, if parameter *TSparameter* is “1”]

The force factor in N/A.

AngleStep [All cases]

The degree step between interpolation points along the circumference. For 2D axisymmetric models the *AngleStep* shall be set to 360 and will internally be overwritten by 18 degrees to perform a 3D-extrapolation of the 2D data for visualisation



Klippel GmbH
Mendelssohnallee 30
01309 Dresden, Germany
www.klippel.de
info@klippel.de



True Technologies Inc.
8309 West Ridge Drive
Pleasant Prairie, WI 53158
USA
www.true-technologies.com
rtrue@true-technologies.com

purpose and enabling the scanners *Radiation Analysis* option. Note that no cyclic information is present in such 2D data; the data is simply rotated along the circumference. An input value of 1 will result in the scanner only showing a difficult to see 2D slice and the scanners *Radiation Analysis* option will not give correct results.

Orientation [All cases, however arbitrary input if 2D]

The orientation must be set according to the FEA. The choice of baffle outwards normal is chosen via one of six option:

1. $-x$
2. $+x$
3. $-y$
4. $+y$
5. $-z$
6. $+z$

Geometry [All cases, however arbitrary input if 2D]

The geometry must be set according to the FEA. The simulation can be either full, cyclic or have one or more symmetry planes:

1. *Full*
2. *Cyclic*
3. *Half (XY)*
4. *Half (XZ)*
5. *Half (YZ)*
6. *Quarter*

CyclicSectors [3D, if parameter *Geometry=1*]

If cyclic symmetry is present a decimal number above 1 must be input determining how many times the geometry in the simulation must be repeated to have a full geometry.

Important: See limitations concerning cyclic FEA-setup.



Klippel GmbH
Mendelssohnallee 30
01309 Dresden, Germany
www.klippel.de
info@klippel.de



True Technologies Inc.
8309 West Ridge Drive
Pleasant Prairie, WI 53158
USA
www.true-technologies.com
rtrue@true-technologies.com

Running the CAL-module in "dB-Lab"

Run FEA2SCN Click the green arrow in the menu:

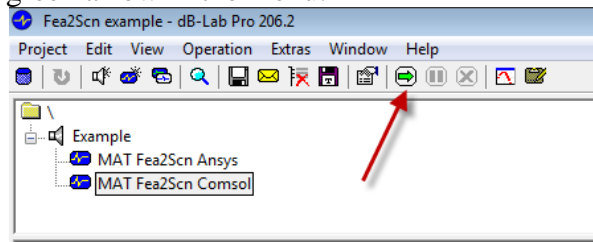

Progress Bars

Several progress bars show the user which process is currently running throughout the FEA2SCN process.

First the input file from the FE analysis is read. A plot shows the geometry of the edge or surface to be scanned, and the frequency currently being read is displayed.

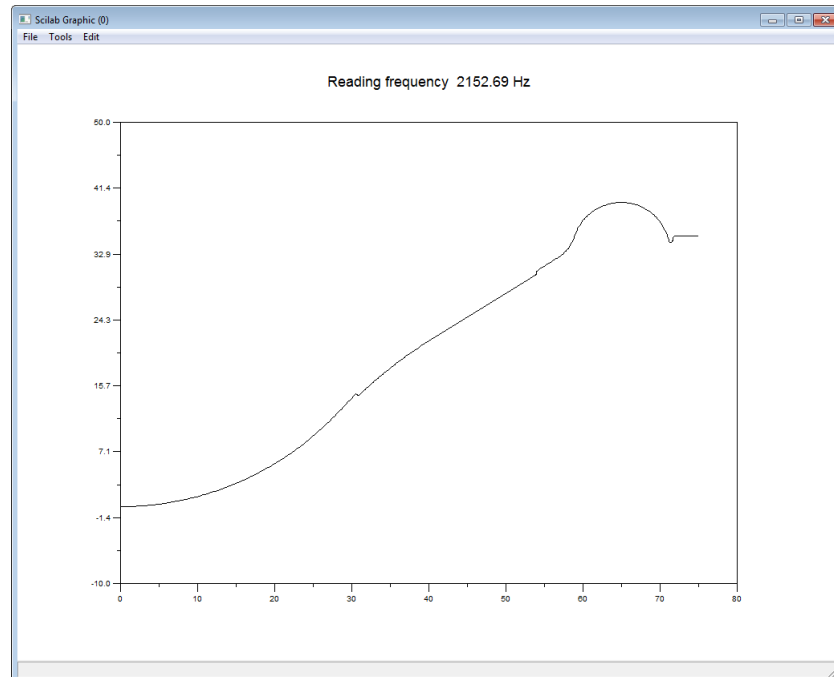

Once the input file has been read the interpolation from FEA mesh nodes to the selected scanner grid point (via the parameters *RadiusStep* and *AngleStep*) starts.



A plot shows the grid for which interpolation values for displacement amplitude, displacement phase and height coordinate have been calculated, and the grid progressively expands as the interpolation process is carried out.

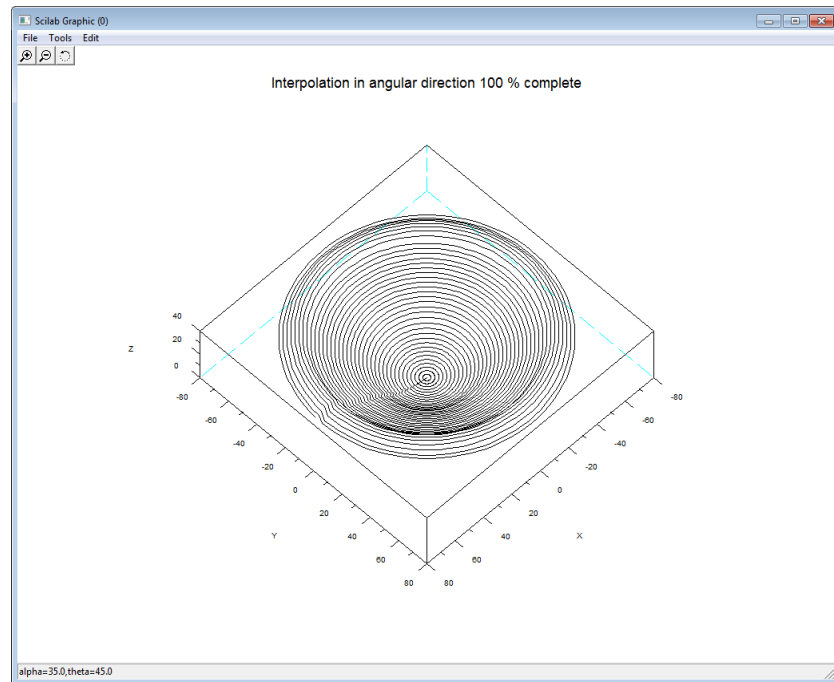

Once all grid points have been assigned their respective values the interpolation is done and the output file called "*Filename Block01to0x.sce*" contains the displacements from the radiating edge/face in a binary format which can be read by the Scanner software.

The Scanner is automatically opened upon interpolation.

It is recommended to export the current FEA2SCN configuration, i.e. mesh resolution, Thiele/Small parameters, input file and so on, in a database file. Click on the disk icon:



and export a *.kdbx file to the folder which holds the input file(s). This way the scanner file can always be recreated or rerun with alternative parameters by double-clicking on the kdbx-file.



Klippel GmbH
Mendelssohnallee 30
01309 Dresden, Germany
www.klippel.de
info@klippel.de



True Technologies Inc.
8309 West Ridge Drive
Pleasant Prairie, WI 53158
USA
www.true-technologies.com
rtrue@true-technologies.com

Running the “SCN Analysis Software”

Reference Voltage SPL

The scanner opens automatically and imports the interpolated file.

Make sure that the correct applied peak voltage is input in the Scanner:

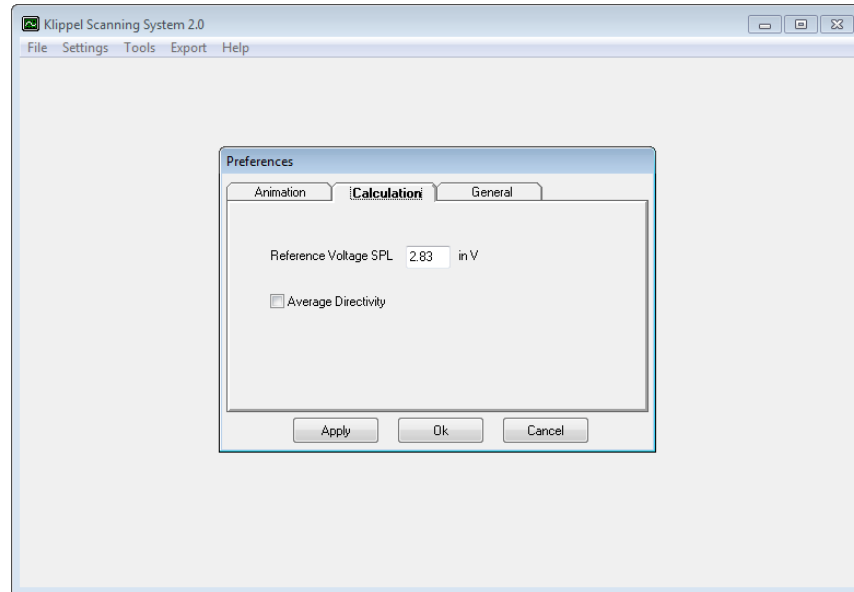

It is assumed that either a voltage of 1 V or a force of 1 N was applied in the Finite Element Analyses.

If the actual input voltage was applied in FEA, the scanner *Reference Voltage SPL* should be set to 1 V in order not to have the voltage “factor” included twice.

If a force different from 1 N was applied, this must be addressed in post-processing.

If the scanned surface is not related to a loudspeaker unit with a certain applied input voltage, the reference voltage can instead be set to give a specific displacement level known from measurements or otherwise.

The data can now be analysed as usual – see Application Note AN31.



Klippel GmbH
Mendelssohnallee 30
01309 Dresden, Germany
www.klippel.de
info@klippel.de



True Technologies Inc.
8309 West Ridge Drive
Pleasant Prairie, WI 53158
USA
www.true-technologies.com
rtrue@true-technologies.com

FEA2SCN Files

Output Files

When FEA2SCN has been run with one (or multiple) input file(s) called "Filename Block01of01.txt" three output files are generated:

- "Filename Blocks01to01.sce"
- "Filename Blocks01to01.bin"
- "Filename Blocks01to01.ksp"

These files are saved in the folder holding the input file. The sce file is a short text file which basically points to the bin file holding the interpolated data. The ksp file is the file which is opened by SCN Analysis Software, and it is linked to the sce file.

NOTE: The sce file points to the bin file using both the full path and the filename. That means that if the ksp is opened remotely from a different PC than the one which was used during the FEA2SCN process or if the files are manually moved to a different directory, the path will effectively change, and the sce file will point to a bin filename which is incorrect. An error message will be shown when opening the ksp file using the SCN Analysis Software:

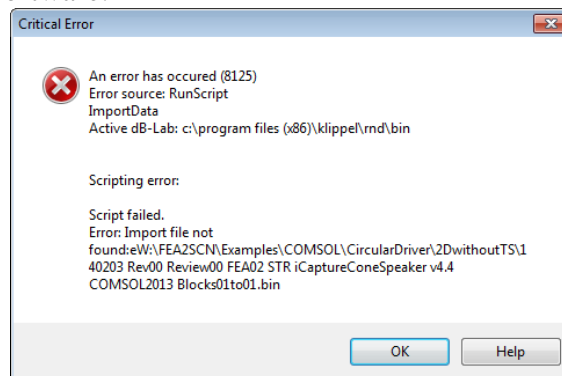

and after clicking OK a message regarding the sce file is shown:

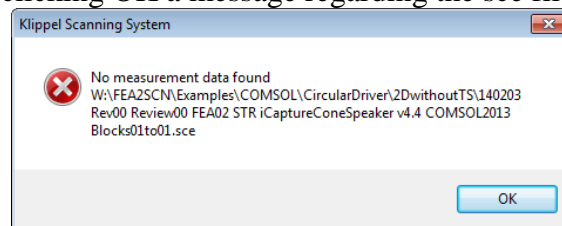

The remedy for this is to open the sce file using a txt editor, find the line pointing to the bin file:

```
// Load externally generated data  
file_bin="W:\Path\Filename Blocks01to01.bin"
```

and correct the path.



Introduction “Ready-To-Scan”-Models

Data via FTP A number of example files has been prepare to try FEA2SCN. Please find them at <http://www.true-technologies.com/fea2scn-more-info.html>.

Download the applicable file set - *COMSOL* or *ANSYS*.

Within each of these two folders called *CircularDriver* and *RectangularDriver* exist.

Here the export files containing displacements and velocities can be found for both COMSOL and ANSYS for the examples listed in the following, except for Example1 which is only available in COMSOL format.

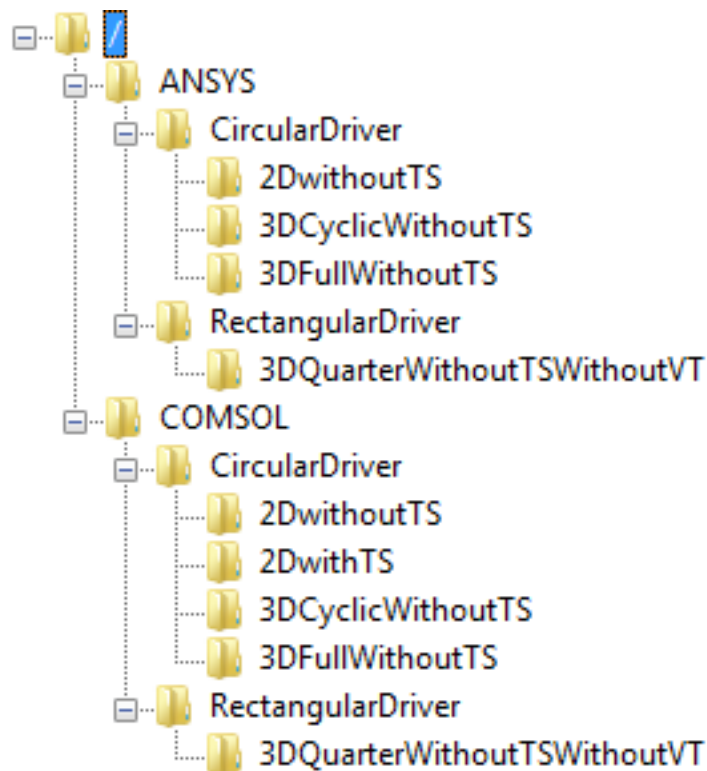

Example 1

Folder: .../COMSOL/CircularDriver/2DwithTS

2D axisymmetric model with T/S-parameters (COMSOL only)

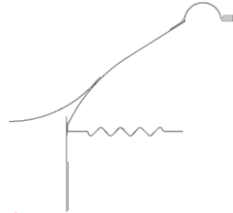

Learning objective: Introduction to “RadiusStep”.

Model description: A 2D model of an electrodynamic loudspeaker placed in a baffle with its normal in the y-direction. The T/S parameters are incorporated in the Finite Element Analysis, and so they shall not be considered when running FEA2SCN. A displacement file has been exported from the analysis.

Import parameters:

<i>InputFile</i>	C:\Filename Block01of01.txt
<i>RadiusStep</i>	1 (Note: Unit is mm)
<i>TSparameters</i>	0
<i>Re</i>	<input type="checkbox"/>
<i>Le</i>	<input type="checkbox"/>
<i>R2</i>	<input type="checkbox"/>
<i>L2</i>	<input type="checkbox"/>
<i>Bl</i>	<input type="checkbox"/>
<i>AngleStep</i>	360
<i>Orientation</i>	4
<i>Geometry</i>	0
<i>CyclicSectors</i>	<input type="checkbox"/>

Result:

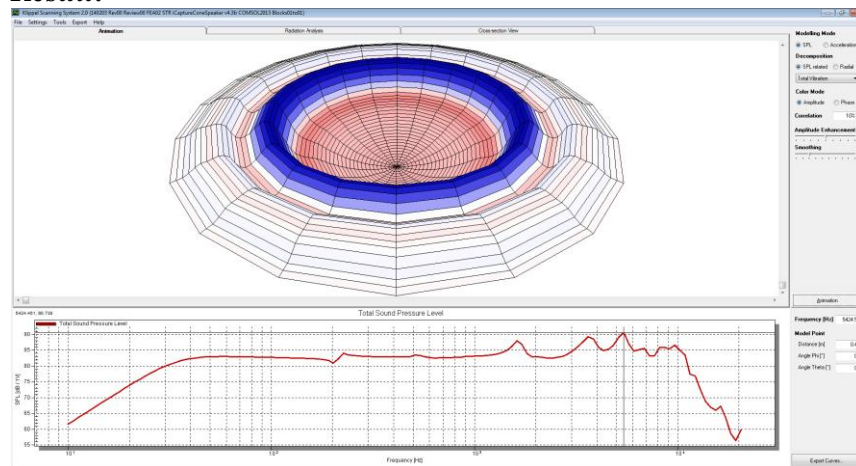

Sound Pressure Level for 1V @ 0.4m

Suggestion: Investigate the sound pressure found using a coarser grid with 2, 3 and 5 mm resolution.



Klippel GmbH
Mendelssohnallee 30
01309 Dresden, Germany
www.klippel.de
info@klippel.de



True Technologies Inc.
8309 West Ridge Drive
Pleasant Prairie, WI 53158
USA
www.true-technologies.com
rtrue@true-technologies.com

Example 2

Folder: .../CircularDriver/2DwithoutTS

2D axisymmetric model without T/S-parameters

Learning objective: Introduction to “TSparameters”, “Re”, “Le”, “R2”, “L2” and “Bl”.

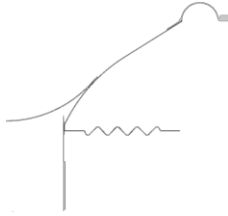

Model description: A 2D model of an electrodynamic loudspeaker placed in a baffle with its normal in the y-direction. The T/S parameters are not incorporated in the Finite Element Analysis, and so they must be included when running FEA2SCN. A displacement file and a velocity file have been exported from the analysis.

Import parameters:

<i>InputFile</i>	C:\Filename Block01of01.txt
<i>RadiusStep</i>	1 (Note: Unit is mm)
<i>TSparameters</i>	1
<i>Re</i>	5.7
<i>Le</i>	0.043 (Note: Unit is mH)
<i>R2</i>	1e-5
<i>L2</i>	0.012 (Note: Unit is mH)
<i>Bl</i>	4
<i>AngleStep</i>	360
<i>Orientation</i>	4
<i>Geometry</i>	0
<i>CyclicSectors</i>	[]

Result:

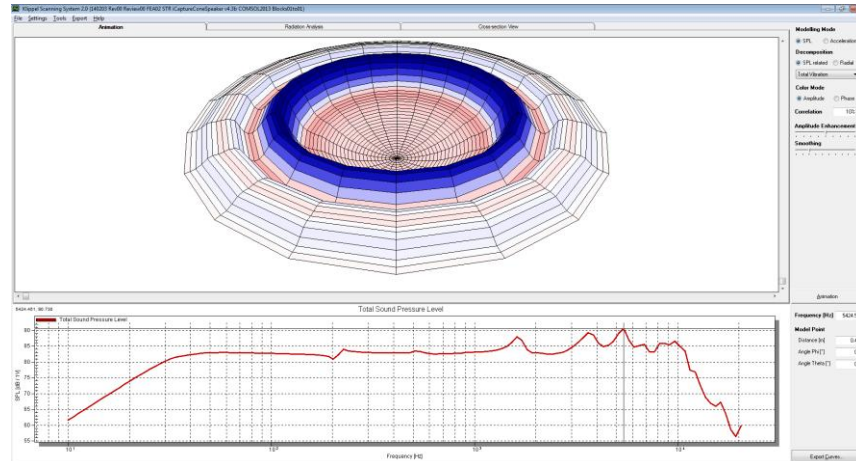

Sound Pressure Level for 1V @ 0.4m

Suggestion: Investigate the effect of changing the suggested Thile/Small parameters on the sound pressure level.



Klippel GmbH
Mendelssohnallee 30
01309 Dresden, Germany
www.klippel.de
info@klippel.de



True Technologies Inc.
8309 West Ridge Drive
Pleasant Prairie, WI 53158
USA
www.true-technologies.com
rtrue@true-technologies.com

Example 3

Folder: .../CircularDriver/3DFullWithoutTS

Full 3D circular model without T/S

Learning objective: Introduction to “AngleStep”.

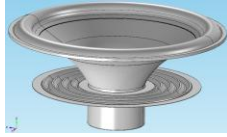

Model description: A 3D model of an electrodynamic loudspeaker placed in a baffle with its normal in the y-direction. The T/S parameters are not incorporated in the Finite Element Analysis, and so they must be included when running FEA2SCN. A displacement file and a velocity file have been exported from the analysis.

Import parameters:

<i>InputFile</i>	C:\Filename Block01of01.txt
<i>RadiusStep</i>	1.5 (Note: Unit is mm)
<i>TSparameters</i>	1
<i>Re</i>	5.7
<i>Le</i>	0.043 (Note: Unit is mH)
<i>R2</i>	1e-5
<i>L2</i>	0.012 (Note: Unit is mH)
<i>Bl</i>	4
<i>AngleStep</i>	18
<i>Orientation</i>	4
<i>Geometry</i>	0
<i>CyclicSectors</i>	[]

Result:

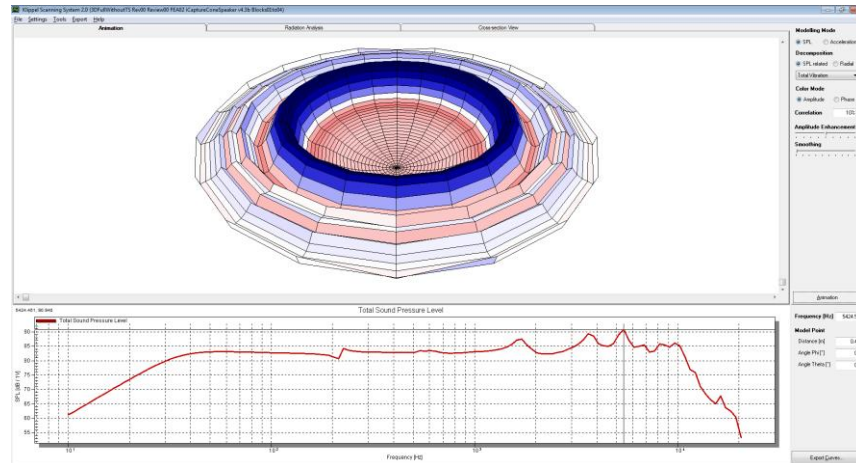

Sound Pressure Level for 1V @ 0.4m

Suggestion: Investigate the effect of changing the angular resolution from the suggested AngleStep of 18 to a coarser resolution of e.g. 72.



Klippel GmbH
Mendelssohnallee 30
01309 Dresden, Germany
www.klippel.de
info@klippel.de



True Technologies Inc.
8309 West Ridge Drive
Pleasant Prairie, WI 53158
USA
www.true-technologies.com
rtrue@true-technologies.com

Example 4

Folder: .../ANSYS/CircularDriver/3DCyclicWithoutTS

**1/16-partial
Cyclic Periodic
3D circular
model without
T/S**

Learning objective: Introduction to “CyclicSectors”.

Model description: A 3D model of an electrodynamic loudspeaker placed in a baffle with its normal in the y-direction and with 1/16 cyclic symmetry. The T/S parameters are not incorporated in the Finite Element Analysis, and so they must be considered when running FEA2SCN. A displacement file and a velocity file have been exported from the analysis. The applied force in the finite element analysis is 1/16 N, equivalent to a total force of 1 N on a full 3D model.

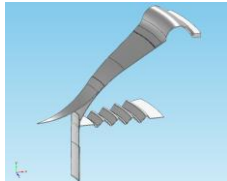

Import parameters:

<i>InputFile</i>	C:\Filename Block01of01.txt
<i>RadiusStep</i>	1 (Note: Unit is mm)
<i>TSparameters</i>	1
<i>Re</i>	5.7
<i>Le</i>	0.043 (Note: Unit is mH)
<i>R2</i>	1e-5
<i>L2</i>	0.012 (Note: Unit is mH)
<i>Bl</i>	4
<i>AngleStep</i>	18
<i>Orientation</i>	4
<i>Geometry</i>	1 (Note: 1 indicates cyclic symmetry)
<i>CyclicSectors</i>	16

Result:

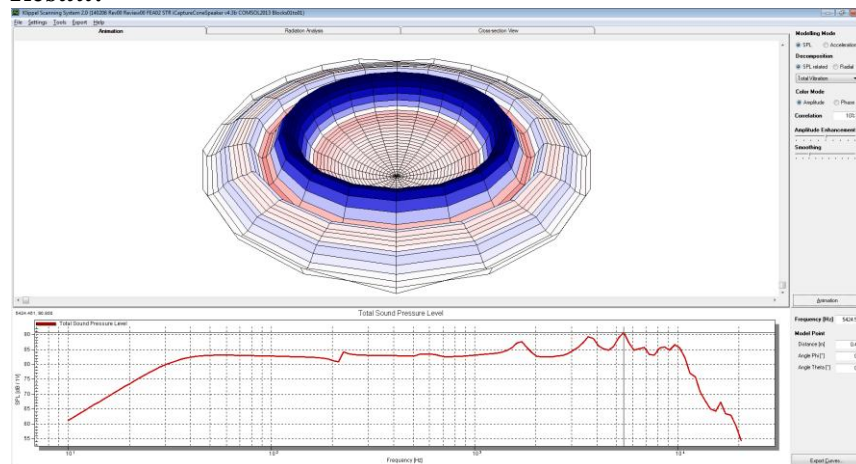

Sound Pressure Level for 1V @ 0.4m

Note: The resulting scan file has been expanded to cover all 16 sections.



Klippel GmbH
Mendelssohnallee 30
01309 Dresden, Germany
www.klippel.de
info@klippel.de



True Technologies Inc.
8309 West Ridge Drive
Pleasant Prairie, WI 53158
USA
www.true-technologies.com
rtrue@true-technologies.com

Example 5

Folder: .../RectangularDriver/3DQuarterWithoutTSWithoutVT

Quarter symmetric 3D model without T/S

Learning objective: “Orientation” and “Geometry”

Model description: A 3D model rectangular shaped electrodynamic microspeaker utilising two symmetry planes. The T/S parameters are not incorporated in the Finite Element Analysis, and so they must be considered when running FEA2SCN. The applied force in the finite element analysis is 1/4 N, equivalent to a total force of 1 N on a full 3D model.

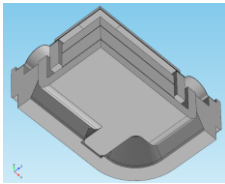
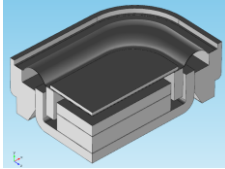

Import parameters:

<i>InputFile</i>	C:\Filename Block01of01.txt
<i>RadiusStep</i>	0.1 (Note: Unit is mm)
<i>TSparameters</i>	1
<i>Re</i>	7
<i>Le</i>	0.05 (Note: Unit is mH)
<i>R2</i>	1
<i>L2</i>	0.01 (Note: Unit is mH)
<i>Bl</i>	0.7
<i>AngleStep</i>	1.8
<i>Orientation</i>	4
<i>Geometry</i>	5 (Note: 5 indicates quarter symmetry)
<i>CyclicSectors</i>	[]

Result:

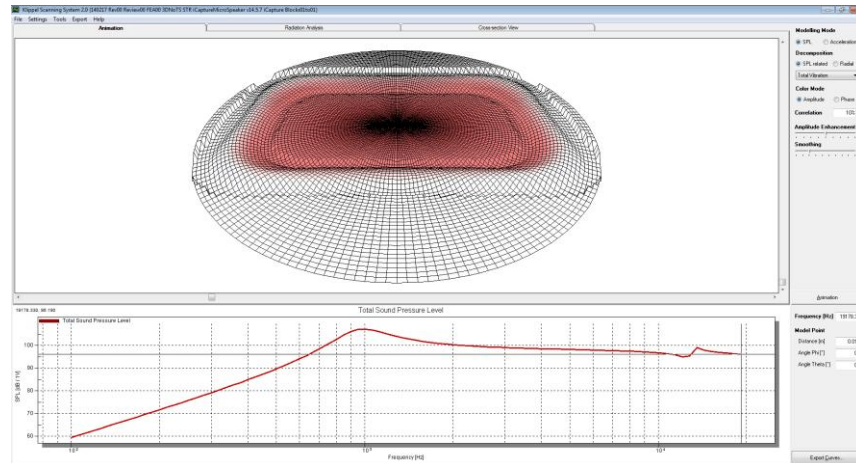

Sound Pressure Level for 1V @ 0.4m

Note: The resulting scan file has been expanded to cover all 4 quadrants of the geometry.



Klippel GmbH
Mendelssohnallee 30
01309 Dresden, Germany
www.klippel.de
info@klippel.de



True Technologies Inc.
8309 West Ridge Drive
Pleasant Prairie, WI 53158
USA
www.true-technologies.com
rtrue@true-technologies.com

More Information

Papers

U. Skov & R. Christensen

"An Investigation of Loudspeaker Simulation Efficiency and Accuracy using A Conventional Model, A Near-To-Far-Field Transformation and The Rayleigh Integral"

Audio Engineering Society Convention Paper 9057, 1-10 (2014).

Abstract:

Simulation on loudspeaker drivers requires a conventional fully coupled vibroacoustic model to capture both the effect of the loading mass of the air on the moving parts and the geometric topology of the cone, dust cap and surround. An accurate vibroacoustic model can be time-consuming to solve, especially in 3D. In practical applications, this results in poor efficiency concerning the decision-making process to move on to the next simulation model. To overcome this the loudspeaker designer can use either a near-to-far-field transformation or post-process structural only results via the Rayleigh integral to reduce or totally eliminate the computationally demanding open air domain in front of the speaker. These simplifications come with the cost of a frequency dependent inaccuracy. This paper compares, for three different drivers (a totally flat, a concave cone and a convex dome), the efficiency and accuracy of a conventional fully-coupled vibroacoustic model where the measurement point is included in the computational FEA domain with respectively, a reduced air domain model having the measurement point outside the computational FEA domain obtained by a near-to-far-field transformation and a model relying on the structural only Rayleigh integral post-processing.

FEA2SCN Version

Version

With FEA2SCN open in "dB-Lab" the current version can be seen by checking the Script box.

Document Revision

140515 Rev00 Initial release.



Klippel GmbH
Mendelssohnallee 30
01309 Dresden, Germany
www.klippel.de
info@klippel.de



True Technologies Inc.
8309 West Ridge Drive
Pleasant Prairie, WI 53158
USA
www.true-technologies.com
rtrue@true-technologies.com